



GEA Hygienic Pumps

Hygienic Pumps

The Heart of GEA Flow Components

Gentle product handling, continued reliability and economic efficiency are key characteristics of the state-of-the-art hygienic pumps in the GEA Flow Components range.

GEA Flow Components

The GEA Flow Components Portfolio comprises hygienic pumps, valve technology and cleaning technology. Our products comply with the highest hygiene standards, such as EHEDG and 3-A.

Our customers' success depends on the quality and profitability of their products. That is why they rely on the advanced technology of GEA Flow Components and on our decades of experience in ensuring smooth processing of liquid products. Our sophisticated process components and service offers for everything that flows are available worldwide from the international GEA sales network.

GEA GROUP AKTIENGESELLSCHAFT

GEA is one of the largest suppliers of process technology for the food industry and for a wide range of other industries. As an international technology group, the company focuses on world-leading process solutions and components for sophisticated production processes.



Every fourth liter of human blood is handled by GEA equipment.



Around one quarter of the milk processed is handled by GEA equipment.

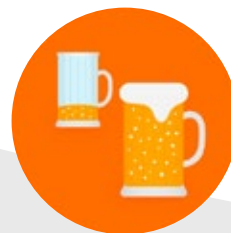

Roughly every second liter of beer is brewed using GEA equipment and solutions.



Approx. one in three instant coffee lines has been built by GEA.



State-of-the-art pump technology, made to our customers' preferences

At the GEA Hilge Hygienic Pumps Center of Competence in Bodenheim we develop innovative pumps and processes together with our customers. Our decades of up-close experience with operations and systems at our customers' production sites ensure optimum selection and configuration of the right pumps for every application.

Maximum efficiency

Two product lines, GEA VARIPUMP and GEA SMARTPUMP, enable our customers to choose from a highly versatile pump range with a multitude of smart adaption options to achieve simpler operation, higher-quality production, and reduced consumption of valuable resources. Special construction features of our pumps provide particularly gentle product handling, delivering top-quality products to our consumers.

Maximum reliability

Our customers rely on the safe, continuous operation of their production systems without unplanned breaks or disturbances. That is why GEA pumps are optimized for uncompromising reliability in all applications. Thanks to their robust design and long service life, they are known as "workhorses" for their ease of maintenance and outstanding service, proven over decades, and for the great number of pumps currently in operation. Of course, GEA pumps also comply with all relevant hygiene standards and norms, with continuous documentation and up-to-date certifications safely ensuring judicial security.

Costs under control

Significant cost savings can be achieved by using GEA pumps. Carefully dimensioned high-efficiency motors ensure low energy consumption. Thanks to simple maintenance, the costs for safeguarding the plant remain manageable.

Long-term partnership

The GEA Hilge Hygienic Pumps Center of Competence in Bodenheim is the contact partner for our customers and partners for the best possible solution. Delivery and services are provided by GEA's worldwide sales and service network. This ensures all-round support throughout the entire life cycle.

Applications

- Beverages: beer, juices, smoothies
- Milk processing: milk, yoghurt, cheese
- Food: sauces, creams, ketchup, mayonnaise
- Pharma: WFI, pharmaceuticals, biochemistry, cosmetics, personal care products
- Chemicals: fine chemicals, basic chemicals, cleaning products
- Numerous other applications

Two modern pump lines

The right solutions – technologically and economically – for each application

Hygienic pumps are used in processes that directly affect product and production. Therefore, the selection and configuration of the right pump requires a lot of experience. The selection matrix for the two pump lines GEA VARIPUMP and GEA SMARTPUMP provides a decision support. The pump types of these two lines are suitable for different requirements and purposes and thus offer the right solution for every application.

The perfect choice

The first parameter to check for selecting the right pump is the complexity of the customer application with regard to the respective system pressures, temperatures and product media.

The second parameter is the required degree of customer-specific adjustment. The overall system concept determines whether standardized pump types or customized engineering will be required.

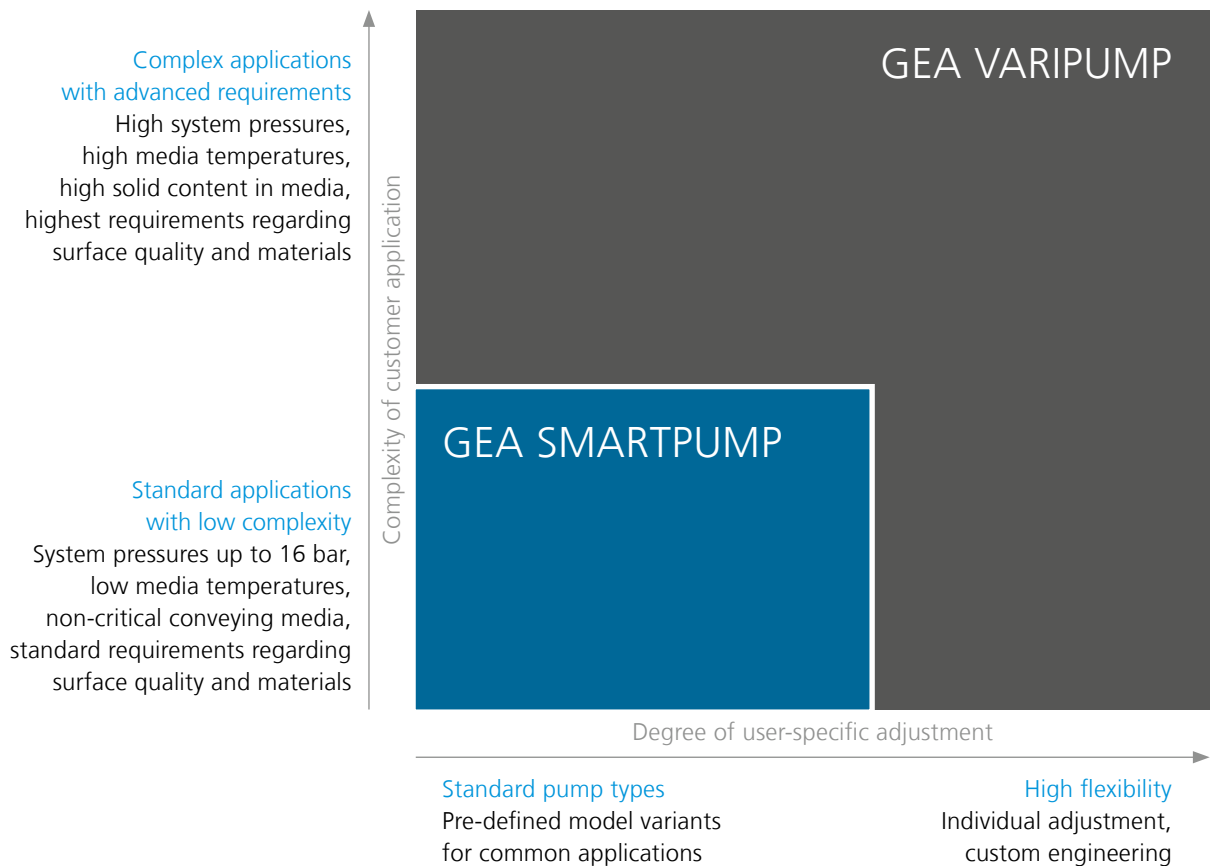

GEA VARIPUMP

Choose GEA VARIPUMP

- If a complex application has high requirements.
- If the pump needs to be adapted to customer requirements.

The pump models in the GEA VARIPUMP line are conceived for extreme application demands and are individually optimized for the customer's task. The high quality surfaces, the construction entirely without die-cast components and the high-value materials meet highest demands even in the sensitive pharma industry. The same goes for added services, e.g. Factory Acceptance Test (FAT). Thanks to a great variety of set-up and customizing options the pumps can adapt to any production process, for lower operational costs and more system efficiency. The longevity of the pumps "Made by GEA" ensures a long-term investment.

Characteristics of the GEA VARIPUMP line:

- Developed for advanced application conditions
- Project-specific customization
- Surface roughness up to $R_a \leq 0.4 \mu\text{m}$
- Selection of materials in contact with product according to specific requirements (e.g. no die-cast components, $\text{Fe} \leq 1 \%$)

GEA SMARTPUMP

Choose GEA SMARTPUMP

- If the complexity of the application is low.
- If the predefined variants meet all given requirements.

The GEA SMARTPUMP line covers common, often used applications at standard conditions. The pumps are highly standardized and attractively priced, easy to select and ready for fast delivery. Within the pre-defined parameters, the standard variants can be configured to individual tasks as planned. The modular construction using high-value materials, the proven "Hygienic Design" and the easy-to-apply, standardized spare parts are great reasons to apply GEA SMARTPUMPs pumps in cost-critical production systems – at no compromise in terms of quality.

Characteristics of the GEA SMARTPUMP line:

- Application for common and clearly defined "standard" process tasks
- Simple selection and configuration
- Fast delivery
- Standardized spare parts

GEA Hygienic Pumps

Program Overview

		GEA VARIPUMP			GEA SMARTPUMP	GEA VARIPUMP	
		Single-stage				Multi-	
		GEA Hilge HYGIA	GEA Hilge MAXA	GEA Hilge TP		GEA Hilge CONTRA	
2-pole, 50 Hz	Max. flow rate [m³/h]	120	320	210		40	
	Max. pump head [m]	72	100	90		160	
	Motor rating [kW]	up to 22.0	up to 90.0	up to 45.0		up to 22.0	
4-pole, 50 Hz	Max. flow rate [m³/h]	110	1,450	100		–	
	Max. pump head [m]	18	62	23		–	
	Motor rating [kW]	up to 7.5	up to 160.0	up to 7.5		–	
2-pole, 60 Hz	Max. flow rate [m³/h]	120	300	240		35	
	Max. pump head [m]	92	100	130		230	
	Motor rating [kW]	up to 22.0	up to 90.0	up to 45.0		up to 22.0	
4-pole, 60 Hz	Max. flow rate [m³/h]	110	480	120		–	
	Max. pump head [m]	26	88	34		–	
	Motor rating [kW]	up to 7.5	up to 160.0	up to 7.5		–	
Surface roughness Ra [µm]		≤ 0.4 / ≤ 0.8 / ≤ 3.2	≤ 0.8 / ≤ 3.2	≤ 3.2		≤ 0.4 / ≤ 0.8 / ≤ 3.2	
Surface roughness Ra [µm]		450 – 500, temporarily 1,000				450 – 500,	

GEA SMARTPUMP

GEA VARIPUMP

GEA SMARTPUMP

GEA VARIPUMP

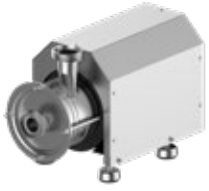

stage

Self-priming

Rotary lobe

**GEA Hilge
DURIETTA**

**GEA Hilge
SIPLA**

**GEA Hilge
TPS**

**GEA Hilge
NOVALOBE**

8	–	125	up to 2.1	Displacement [l/rev]
72	–	95		
up to 2.2	–	up to 45.0	up to 16	Max. differential pressure [bar]
5	78	–		
3	47	–	up to 95 150 (SIP)	Max. liquid temperature [°C]
0.25	up to 22.0	–		
8	–	155	uni-wing bi-wing multilobe	Rotor design
41	–	138		
up to 2.2	–	up to 45.0	≤ 0.4 / ≤ 0.8	Surface roughness R _a [µm]
3	64	–		
3	60	–	up to 41	Max. particle size [mm] (non-abrasive)
0.25	up to 22.0	–		
≤ 3.2	≤ 3.2	≤ 3.2	1,000,000	Max. viscosity [mPas]
temporarily 1,000	800 – 1,000	500		

GEA Hilge HYGIA

More flexibility for your demanding process applications – the premium pump series GEA Hilge HYGIA in the GEA VARIPUMP line consists of single-stage end-suction centrifugal pumps, constructed for use in industries with high demands to hygiene and flexibility.



The materials used for GEA Hilge HYGIA pumps have been selected for the use in hygienic processes. The housings are made of CrNiMo rolled steel (1.4404 / 1.4435) and have a smooth surface without pores and blowholes.

Areas of Application

The GEA Hilge HYGIA pump can be flexibly employed in all application ranges in which reliable hygienic pump function is required. This includes the following areas:

Food & Beverage Industry

- Beer/breweries
- Dairies
- Soft drinks
- Yeast processing

Life Science/Pharmaceuticals Industry

- Pumping of sterile and pure water (WFI)
- Biotechnology
- Infusions (nutrient solutions, alcohol)
- Filling stations

Personal Care

- Purified water
- Lotions
- Perfumes

Additional Industrial Applications

- Cleaning processes (CIP systems)
- Water technology processes
- Semiconductor production
- Metal surface treatment
- Bio fuel
- Water treatment systems
- Textile industry

Certificates and Documents

- Inspection certificate 3.1 acc. to DIN EN 10204
- EHEDG and 3-A certified
- FDA and USP Class VI declaration of conformity
- Surface roughness measurement

GEA HILGE HYGIA PERFORMANCE CURVES

2-POLE, 50 HZ

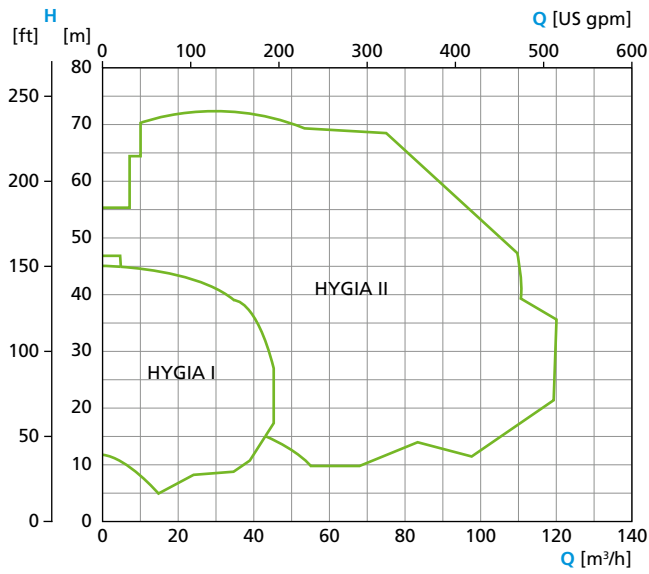

2-POLE, 60 HZ

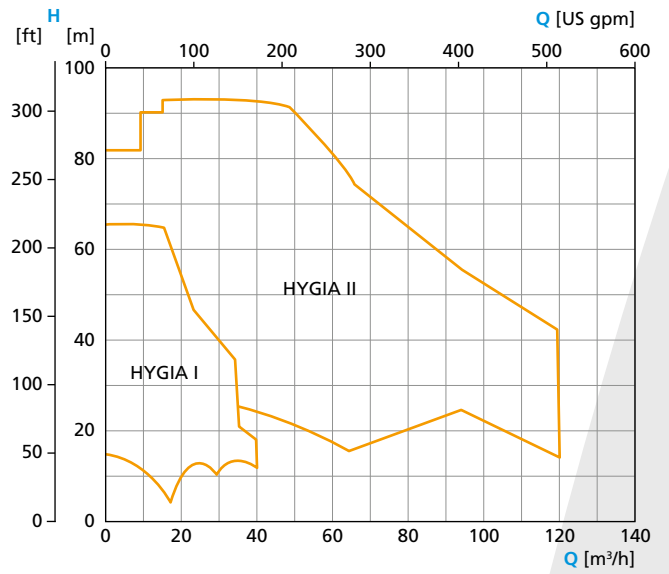

4-POLE, 50 HZ

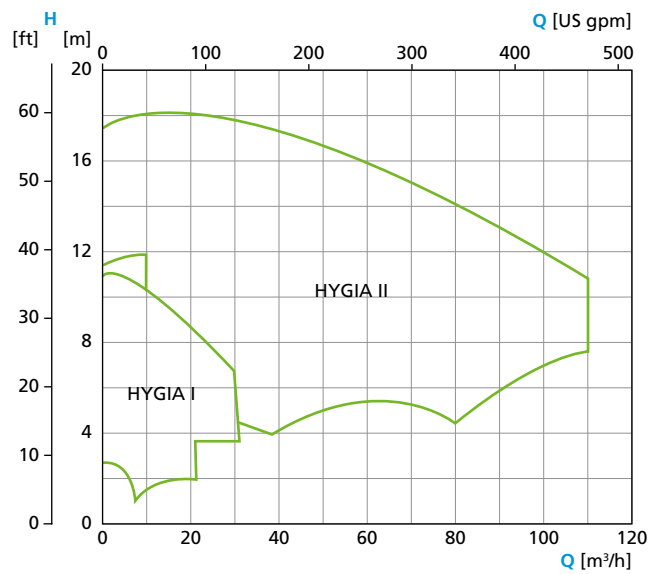

4-POLE, 60 HZ

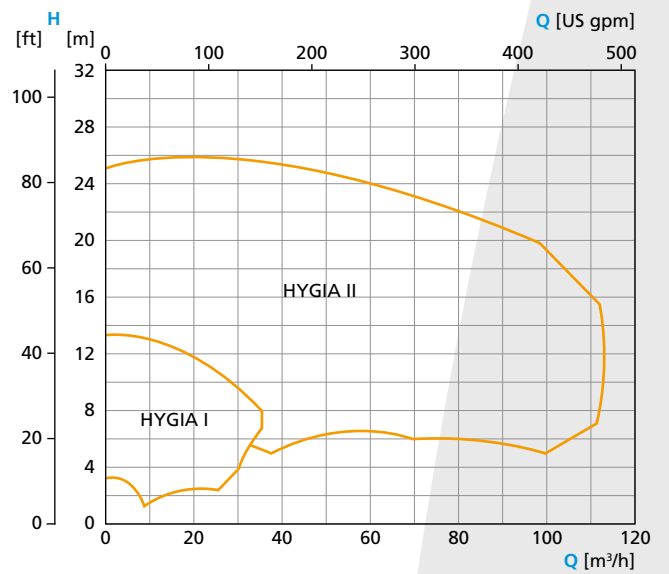

GEA Hilge MAXA

Heavy-duty pumps for industrial processes – the GEA Hilge MAXA range in the GEA VARIPUMP line offers single-stage end-suction centrifugal pumps designed for heavy-duty operation in industrial processes.



The GEA Hilge MAXA range is made from welded, rolled stainless steel in AISI 316L (1.4404). Flexible mounting options are available, such as a close-coupled pump, a close-coupled pump with bearing bracket or a base plate pump version (with motors up to 160 kW).

Areas of Application

The highly reliable GEA Hilge MAXA pumps are suitable for:

Food & Beverage Industry

- Breweries – gentle pumping of mash and wort along with beer filtration
- Dairy
- Food processing
- CIP systems

Additional Industrial Applications

- Water treatment systems
- Chemical handling
- Liquids with high contents of solids
- Bio fuels

Certificates and Documents

- Inspection certificate 3.1 acc. to DIN EN 10204
- FDA and EHEDG certificates
- Surface roughness test report

GEA HILGE MAXA PERFORMANCE CURVES

2-POLE, 50 HZ

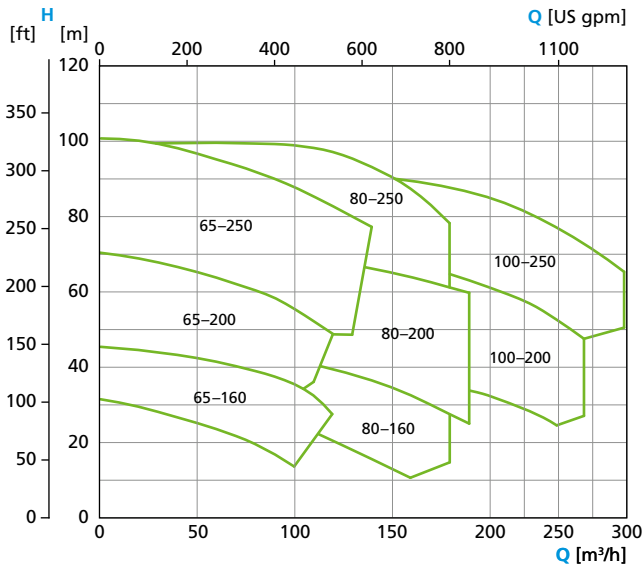

2-POLE, 60 HZ

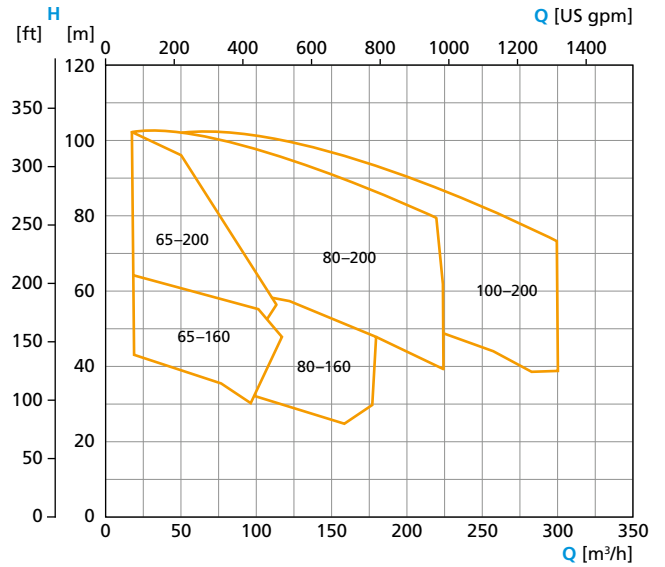

4-POLE, 50 HZ

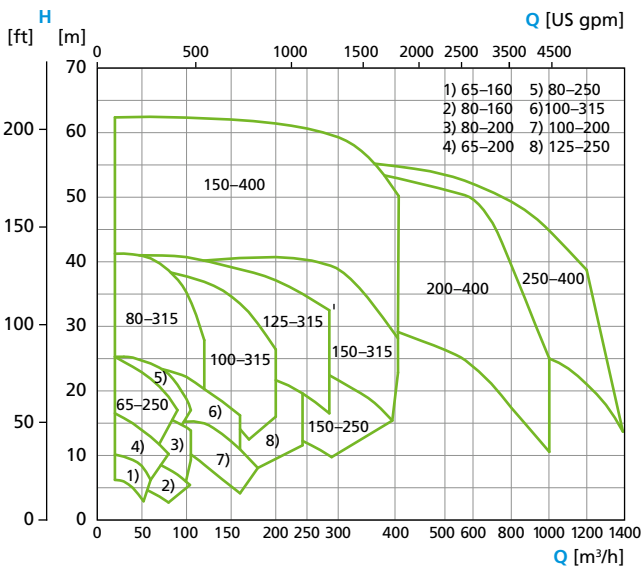

4-POLE, 60 HZ

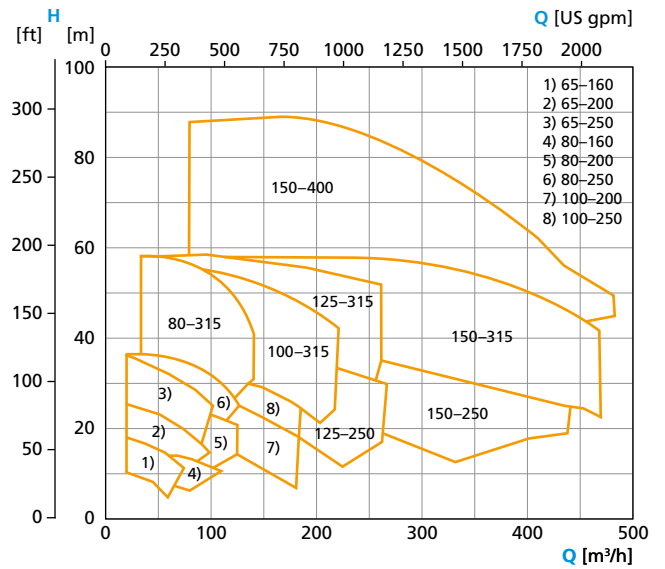

6-POLE, 50 HZ

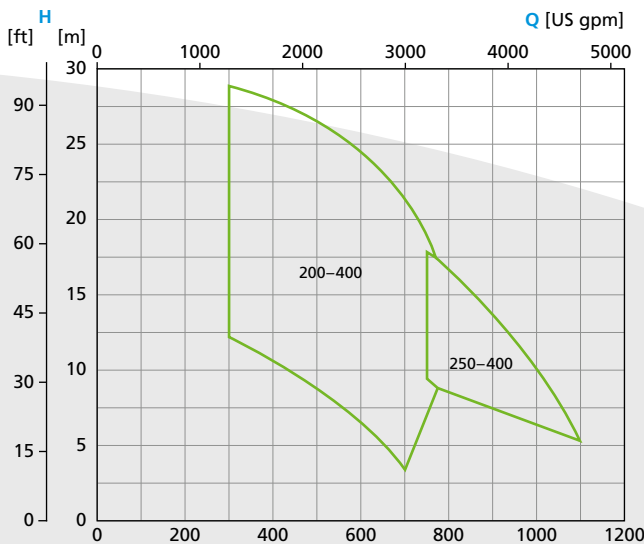

6-POLE, 60 HZ

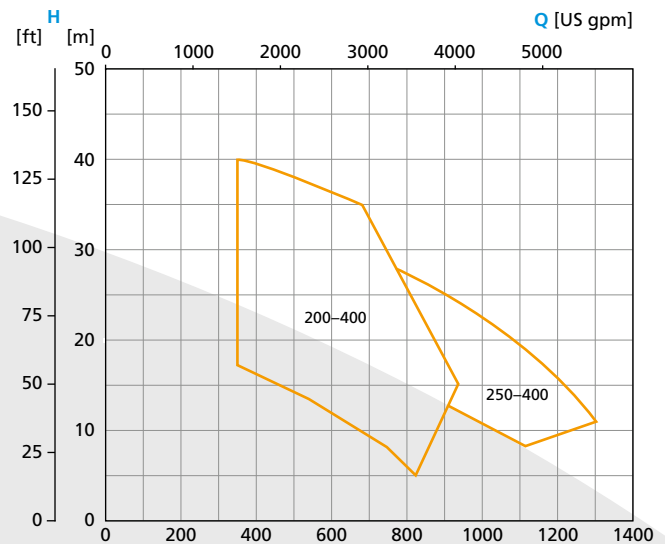

GEA Hilge TP

Sustainable and economical application under hygienic conditions – The energy-efficient and hygienic GEA Hilge TP centrifugal pumps in the GEA SMARTPUMP line are available in a variety of model sizes, optimally configured for different applications.



The centrifugal pump GEA Hilge TP is designed for the hygienic pumping in different applications. Low flow velocities and gentle discharge of media through the spiral housing enables extremely gentle product handling. 11 different pump types are available covering a large capacity range, fine tuned for each task.

Areas of Application

The GEA Hilge TP series has been designed for a variety of applications within:

Food & Beverage Industry

- Breweries
- Dairies
- Soft Drinks
- Yeast Processing

Personal Care

- Purified water
- Lotions
- Perfumes

Additional Industrial Applications

- Cleaning processes (CIP systems)
- Water technology processes
- Metal surface treatment

Certificates and Documents

- Inspection certificate 3.1 acc. to DIN EN 10204
- 3-A and EHEDG certificates
- FDA and USP Class VI declaration of conformity

GEA HILGE TP PERFORMANCE CURVES

2-POLE, 50 HZ

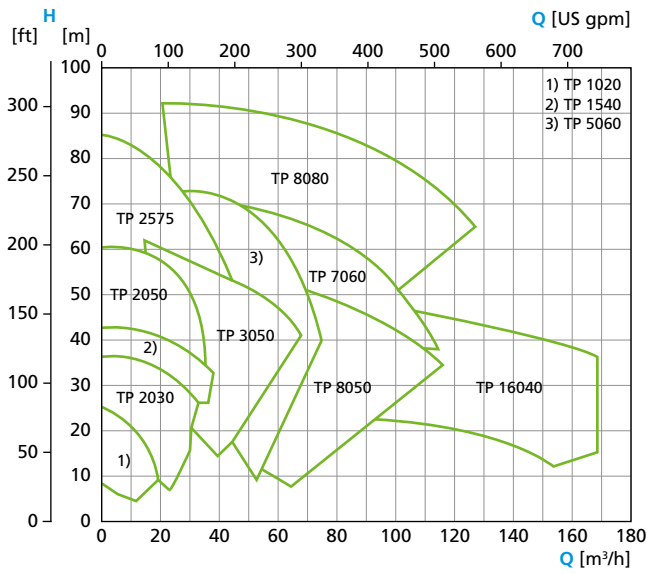

2-POLE, 60 HZ

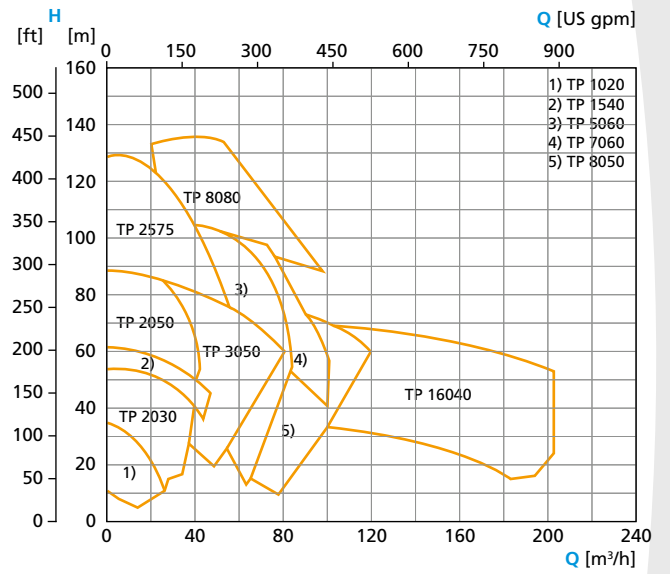

4-POLE, 50 HZ

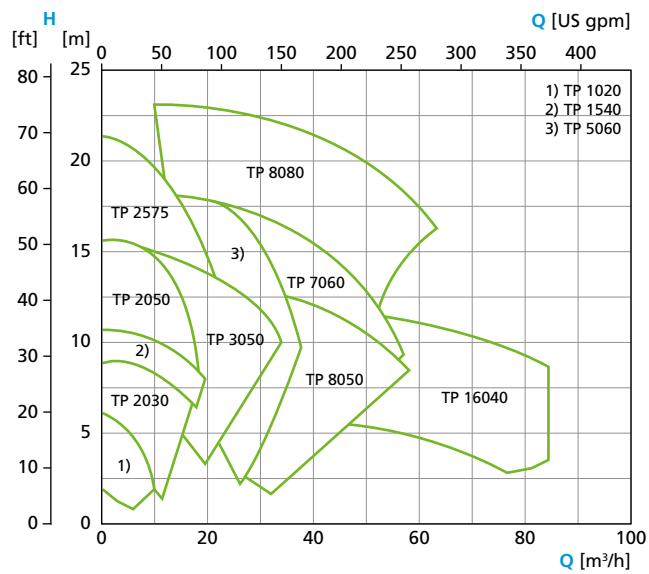

4-POLE, 60 HZ

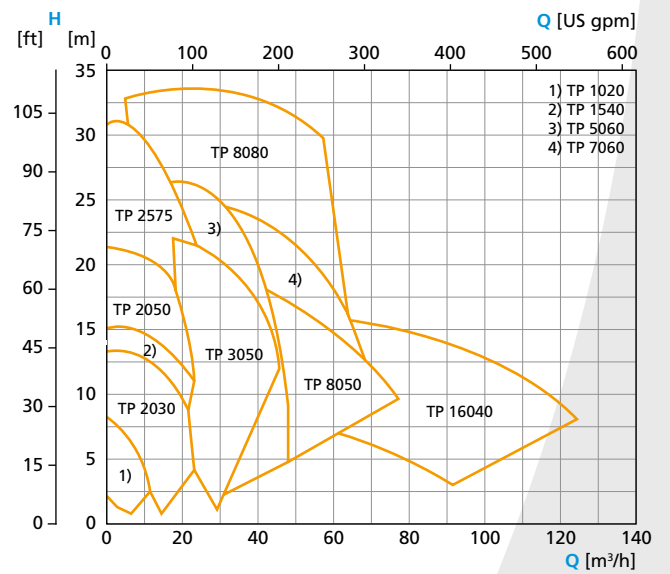

GEA Hilge CONTRA

Certified safe performance for your demanding processes –
The GEA Hilge CONTRA range in the GEA VARIPUMP line offers single or multi-stage, end-suction centrifugal pumps.



The pumps are CIP- and SIP-capable according to DIN EN 12462, meeting the world's highest hygiene standards. Apart from DIN, ASME and ANSI connections, a flexible range of custom connections is available upon request.

Areas of Application

The GEA Hilge CONTRA pumps are extremely reliable under tough operating conditions. Their hygienic design and the use of pore-free materials make them suitable within:

Food and Beverage Industry

- Dairies
- Carbonizing in breweries
- CIP-feeding

Pharmaceutical Industry

- Pumping of pure water (WFI)
- Biotech production
- Infusions (nutrient solutions, alcohol)
- Filling stations

Personal Care

- Soap
- Creme
- Lotions

Additional Industrial Applications

- Cleaning processes (CIP systems)
- Water technology processes
- Semiconductor production
- Metal surface treatment

Certificates and Documents

- Inspection certificate 3.1 acc. to DIN EN 10204
- EHEDG certificate
- FDA and USP Class VI declaration of conformity
- Surface roughness test report

GEA HILGE CONTRA PERFORMANCE CURVES

2-POLE, 50 HZ

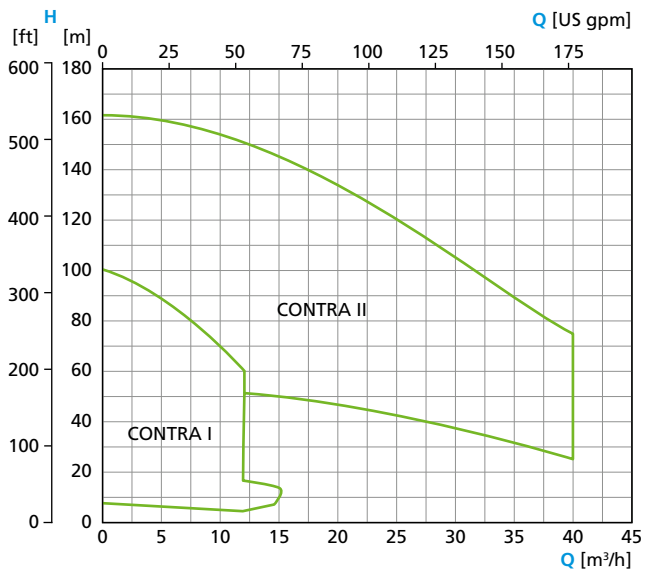

2-POLE, 60 HZ

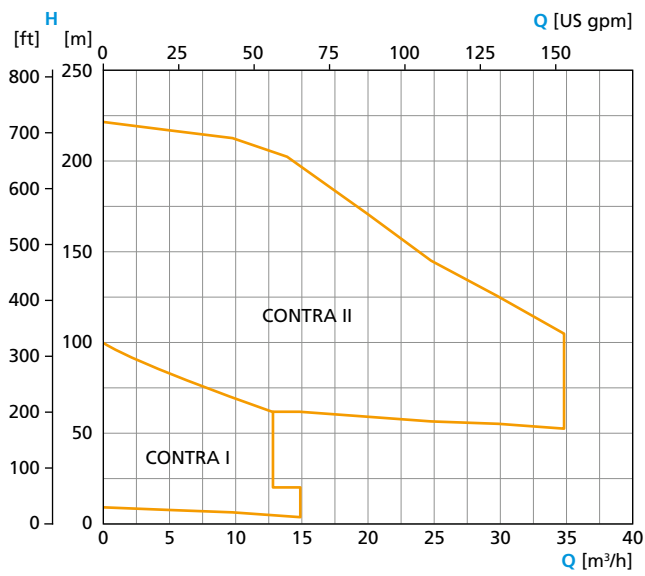

GEA Hilge DURIETTA

Smart, safe and compact for your hygienic production processes – The GEA Hilge DURIETTA in the GEA SMARTPUMP line for standard applications is a close-coupled end-suction single- or multi-stage centrifugal pump created for all kinds of applications under hygienic conditions.

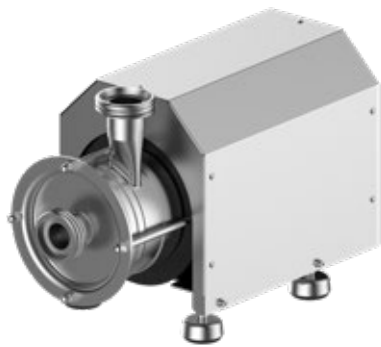

The GEA Hilge DURIETTA is designed in compliance with food technology requirements, making it ideal for jobs where hygiene is a key concern. For example, it is CIP- and SIP-capable with the performance characteristics outlined for pumps in DIN 12462.

Areas of Application

The unique hygienic design and the deep-drawn, rolled stainless steel AISI 316L make the GEA Hilge DURIETTA pump range suitable for:

Food and Beverage Industry

- Microbreweries
- Dairies
- Bottling systems
- Food processing plants
- Drinking water systems

Pharmaceutical and Related Industry

- Personal care industries
- CIP systems

Additional Industrial Applications

- Semi-conductor manufacturing
- Heat exchangers

Certificates and Documents

- EAC certificate
- FDA and USP Class VI declaration of conformity

GEA HILGE DURIETTA PERFORMANCE CURVES

2-POLE, 50 HZ

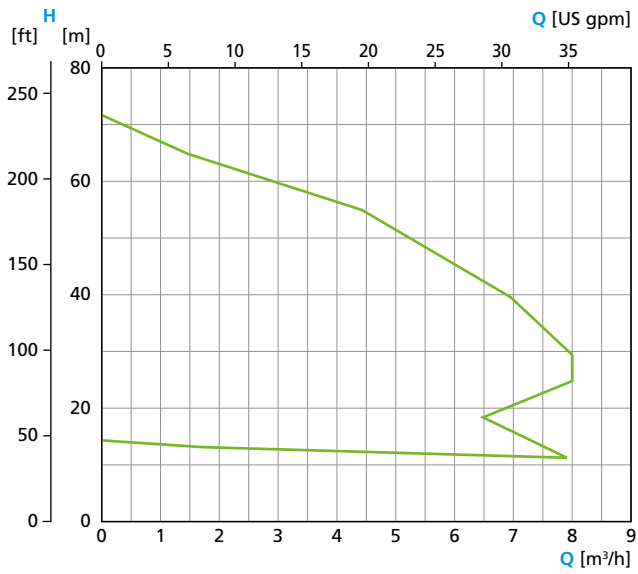

2-POLE, 60 HZ

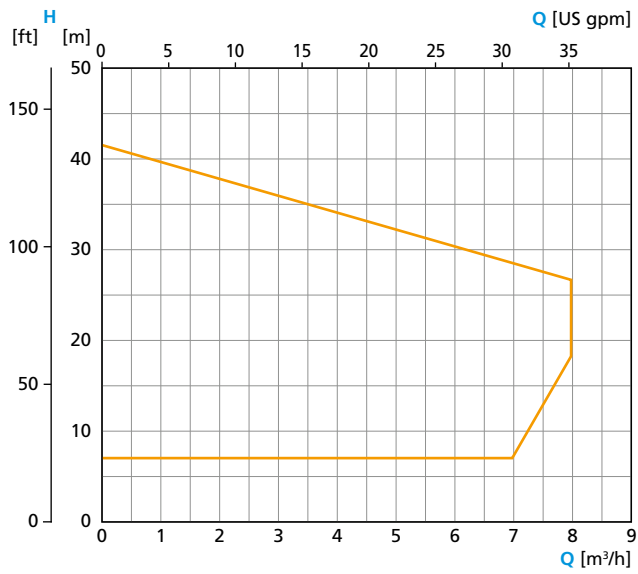

GEA Hilge SIPLA

These single-stage self-priming side channel pumps for demanding applications optimize your cleaning processes. GEA Hilge SIPLA stands for high reliability and ensures a smooth production process.



The GEA Hilge SIPLA range offers single-stage self-priming side channel pumps. The top casing connections ensure that GEA Hilge SIPLA pumps are not drained when not running. Robustness characterizes the components of the GEA Hilge SIPLA pump family. The all-stainless steel construction exemplifies the commitment at GEA Hilge to quality and efficiency.

Areas of Application

The GEA Hilge SIPLA range offers superior quality in every detail and unmatched reliability in most applications. These self-priming pumps can be relied on for a long operational lifetime, even under tough conditions, including liquids with a high air content, such as in SIP/CIP return systems.

Food and Beverage Industry

- Breweries
- Dairies
- Soft Drinks
- Yeast Processing

Additional Industrial Applications

- Pharmaceutical Industry
- Cleaning processes (CIP systems)
- Conveying products containing gas

Certificates and Documents

- Inspection certificates 3.1 acc. to DIN EN 10204
- FDA and USP Class VI declaration of conformity

GEA HILGE SIPLA PERFORMANCE CURVES

4-POLE, 50 HZ

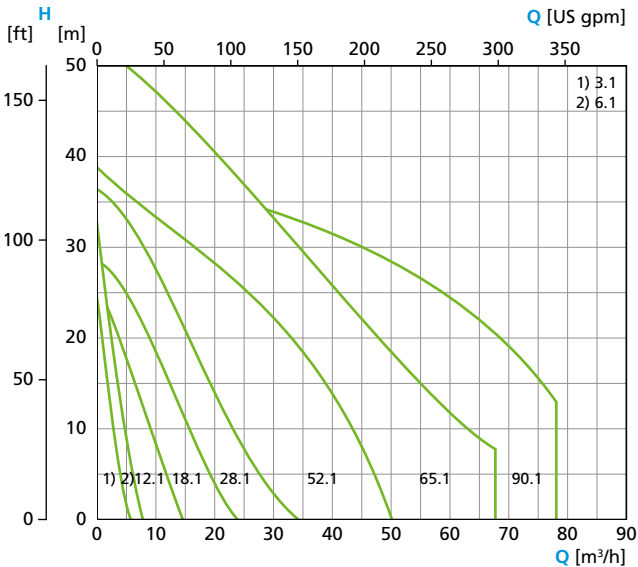

4-POLE, 60 HZ

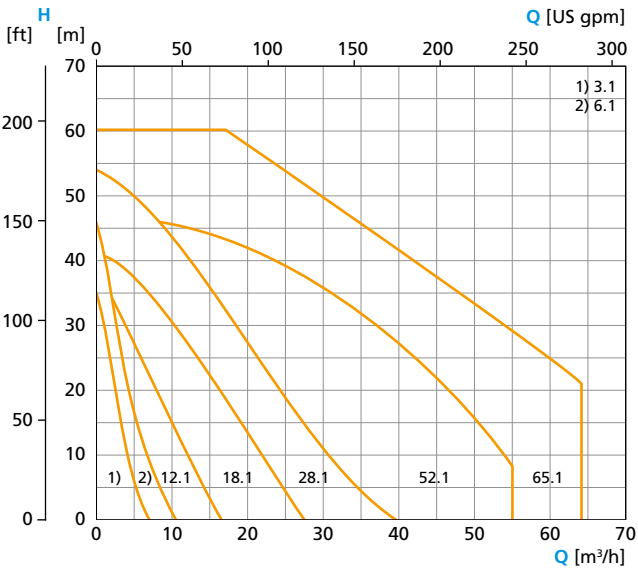

GEA Hilge TPS

Sustainable and economical application under hygienic conditions – The self-priming, hygienic GEA Hilge TPS centrifugal pumps are available in four model sizes and are optimized for a variety of applications.

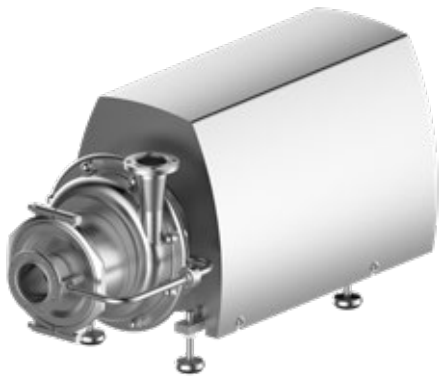

The centrifugal pump GEA Hilge TPS is a self-priming pump for viscosities of up to 500 mPas. The TPS is characterized by a low sound level, highest efficiency and excellent cleaning properties. The GEA Hilge TPS series also permits evacuation of pipes on the suction side – so that just one pump is required for CIP return and product conveying.

Areas of Application

The GEA Hilge TPS series has been designed for a variety of applications within:

Food and Beverage Industry

- Breweries
- Dairies
- Soft Drinks
- Yeast Processing

Additional Industrial Applications

- Pharmaceutical Industry
- Cleaning processes (CIP systems)
- Conveying products containing gas

Certificates and Documents

- Inspection certificate 3.1 acc. to DIN EN 10204
- 3-A and EHEDG certificates
- FDA and USP Class VI declaration of conformity

GEA HILGE TPS PERFORMANCE CURVES

2-POLE, 50 HZ

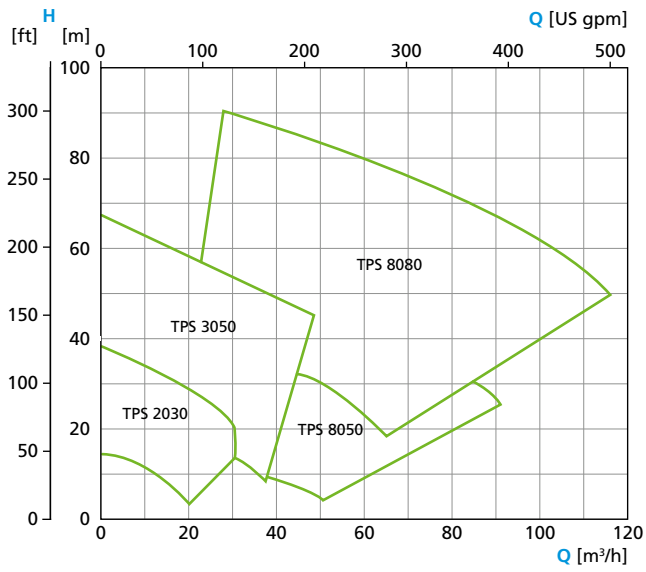

2-POLE, 60 HZ

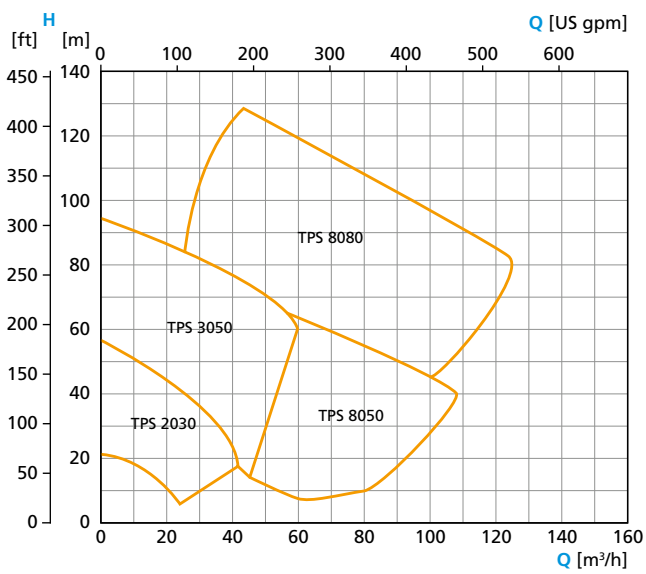

GEA Hilge NOVALOBE

Revolutionary design for viscous media – The GEA Hilge NOVALOBE range is specifically designed for highly viscous media.

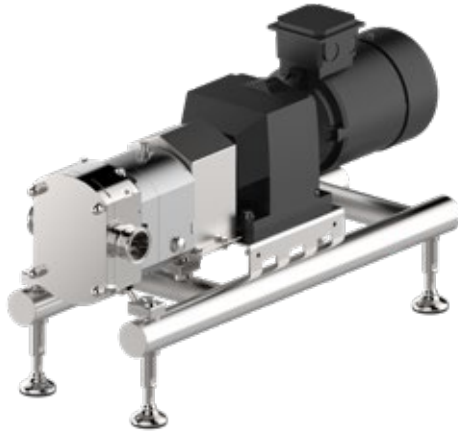

Through the pump's robust construction the shaft overhang and clearance in the pump have been minimized. The pump's compact design and the rigid shaft geometry reduce the risk of galling to an absolute minimum.

Areas of Application

The GEA Hilge NOVALOBE pumps offer extremely reliable operation and gentle product handling. The hygienic design and use of pore-free materials make the pumps suitable for a variety of applications, such as:

Food and Beverage Industry

- Dairies
- Food processing plants
- Soft drinks
- Confectionary and sugar
- Meat industry
- Breweries

Pharmaceutical, Biotechnology and Personal Care

- Fermentation processes
- Vaccine
- Blood products
- Enzyme production
- Cosmetics
- Personal care

Additional Industrial Applications

- Paper
- Textile
- Chemical

Certificates and Documents

- Inspection certificate 3.1 acc. to DIN EN 10204
- EHEDG certificate
- FDA and USP Class VI declaration of conformity

PROGRAM OVERVIEW

Pump model	NOVALOBE 10/0.06	NOVALOBE 20/0.12	NOVALOBE 30/0.33	NOVALOBE 40/0.65	NOVALOBE 50/1.29	NOVALOBE 60/2.1
Displacement (l/rev)	0.06	0.12	0.33	0.65	1.29	2.1
Differential pressure (bar)	16	16	16	16	16	10
Max. speed (rpm)	1,500	1,500	1,250	1,000	800	500
Max. liquid temperature	up to 95 °C, 150 °C (SIP)	up to 95 °C, 150 °C (SIP)	up to 95 °C, 150 °C (SIP)	up to 95 °C, 150 °C (SIP)	up to 95 °C, 150 °C (SIP)	up to 95 °C, 150 °C (SIP)
Rotor design	uni-wing bi-wing multilobe	uni-wing bi-wing multilobe	uni-wing bi-wing multilobe	uni-wing bi-wing multilobe	uni-wing bi-wing multilobe	bi-wing multilobe
Surface roughness R_a (µm)	$\leq 0.8 / \leq 0.4^1$	$\leq 0.8 / \leq 0.4^1$	$\leq 0.8 / \leq 0.4^1$	$\leq 0.8 / \leq 0.4^1$	$\leq 0.8 / \leq 0.4^1$	$\leq 0.8 / \leq 0.4^1$
Connection size (mm)	25	40	50	65	80	100
Max. particle size (mm) (non-abrasive)	12	16	23	29	35	41
Max. viscosity (mPas)	1,000,000	1,000,000	1,000,000	1,000,000	1,000,000	1,000,000

¹ optional

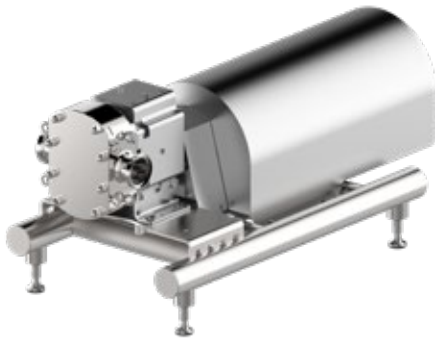

GEA Hilge NOVALOBE 60
on sterile base frame with
stainless steel shroud



GEA Hilge NOVALOBE 10 vertical



GEA Hilge NOVALOBE
with thermal jacket



GEA Hilge NOVALOBE
with pressure relief valve



We live our values.

Excellence • Passion • Integrity • Responsibility • GEA-versity

GEA is a global technology company with multi-billion euro sales operations in more than 50 countries. Founded in 1881 the company is one of the largest providers of innovative equipment and process technology. GEA is listed in the STOXX® Europe 600 Index. In addition, the company is included in selected MSCI Global Sustainability Indexes.

GEA Germany

GEA Hilge

Niederlassung der GEA Tuchenhagen GmbH

Hilgestraße 37–47

55294 Bodenheim, Germany

Tel +49 6135 7016-0

Fax +49 6135 1737

sales.germany@gea.com

gea.com